

DATA SHEET

BF545A; BF545B; BF545C N-channel silicon junction field-effect transistors

Product specification
Supersedes data of April 1995
File under Discrete Semiconductors, SC07

1996 Jul 29

N-channel silicon junction field-effect transistors

BF545A; BF545B; BF545C

FEATURES

- Low leakage level (typ. 500 fA)
- High gain
- Low cut-off voltage (max. 2.2 V for BF545A).

APPLICATIONS

- Impedance converters in e.g. electret microphones and infra-red detectors
- VHF amplifiers in oscillators and mixers.

DESCRIPTION

N-channel symmetrical silicon junction field-effect transistors in a SOT23 package.

PINNING - SOT23

PIN	SYMBOL	DESCRIPTION
1	s	source
2	d	drain
3	g	gate

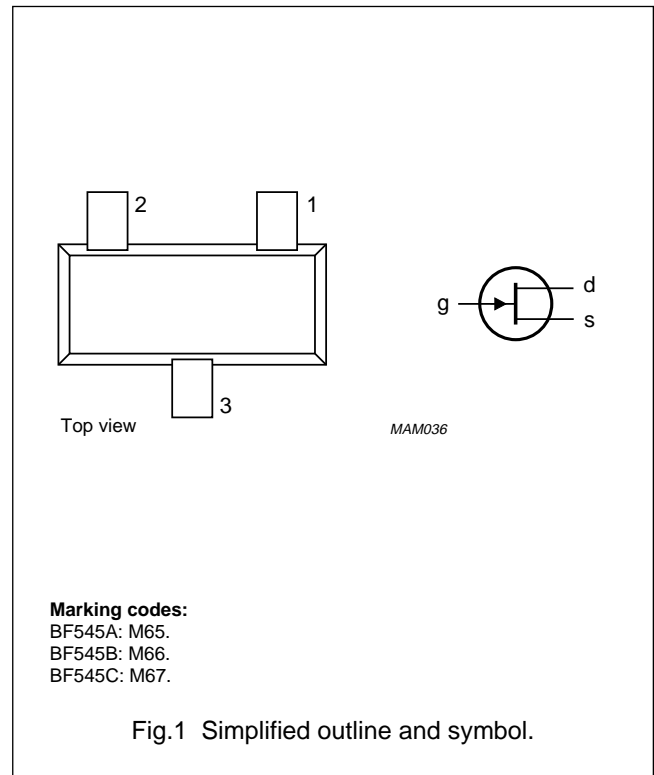

QUICK REFERENCE DATA

SYMBOL	PARAMETER	CONDITIONS	MIN.	MAX.	UNIT
V_{DS}	drain-source voltage		–	± 30	V
V_{GSoff}	gate-source cut-off voltage	$I_D = 1 \mu A; V_{DS} = 15 V$	-0.4	-7.8	V
I_{DSS}	drain current	$V_{GS} = 0; V_{DS} = 15 V$			
	BF545A		2	6.5	mA
	BF545B		6	15	mA
	BF545C		12	25	mA
P_{tot}	total power dissipation	up to $T_{amb} = 25 \text{ }^\circ\text{C}$	–	250	mW
$ y_{fs} $	forward transfer admittance	$V_{GS} = 0; V_{DS} = 15 V$	3	6.5	mS

N-channel silicon junction
field-effect transistors

BF545A; BF545B; BF545C

LIMITING VALUES

In accordance with the Absolute Maximum Rating System (IEC 134).

SYMBOL	PARAMETER	CONDITIONS	MIN.	MAX.	UNIT
V _{DS}	drain-source voltage		–	±30	V
V _{GSO}	gate-source voltage	open drain	–	–30	V
V _{GDO}	gate-drain voltage (DC)	open source	–	–30	V
I _G	forward gate current (DC)		–	10	mA
P _{tot}	total power dissipation	up to T _{amb} = 25 °C; note 1	–	250	mW
T _{stg}	storage temperature		–65	150	°C
T _j	operating junction temperature		–	150	°C

Note

1. Device mounted on an FR4 printed-circuit board, maximum lead length 4 mm; mounting pad for the drain lead 10 mm².

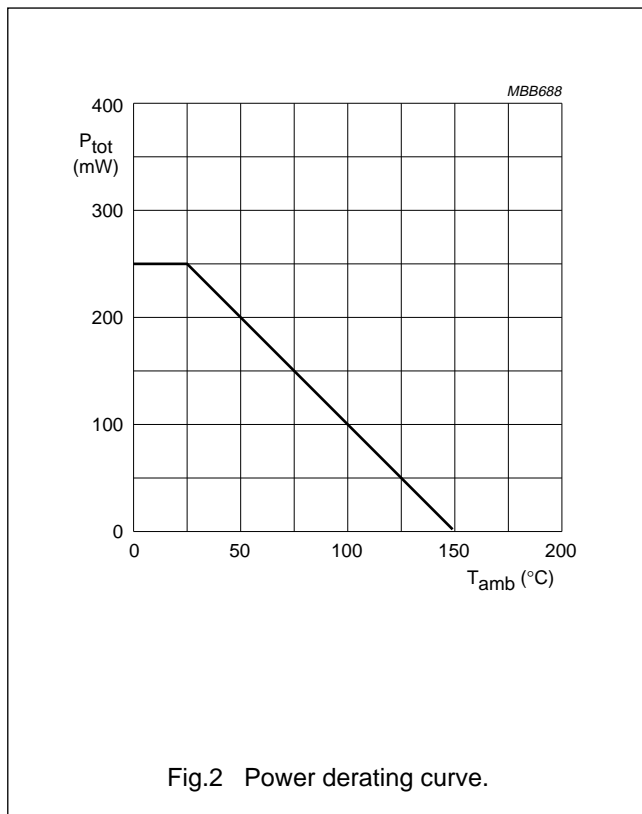

N-channel silicon junction field-effect transistors

BF545A; BF545B; BF545C

THERMAL CHARACTERISTICS

SYMBOL	PARAMETER	VALUE	UNIT
$R_{th\ j-a}$	thermal resistance from junction to ambient; note 1	500	K/W

Note

1. Device mounted on an FR4 printed-circuit board, maximum lead length 4 mm; mounting pad for the drain lead 10 mm².

STATIC CHARACTERISTICS

$T_j = 25\text{ °C}$; unless otherwise specified.

SYMBOL	PARAMETER	CONDITIONS	MIN.	TYP.	MAX.	UNIT	
$V_{(BR)GSS}$	gate-source breakdown voltage	$I_G = -1\ \mu\text{A}; V_{DS} = 0$	-30	-	-	V	
V_{GSoff}	gate-source cut-off voltage	$I_D = 200\ \mu\text{A}; V_{DS} = 15\ \text{V}$	BF545A	-0.4	-	-2.2	V
			BF545B	-1.6	-	-3.8	V
			BF545C	-3.2	-	-7.8	V
		$I_D = 1\ \mu\text{A}; V_{DS} = 15\ \text{V}$	-0.4	-	-7.5	V	
I_{DSS}	drain current	$V_{GS} = 0; V_{DS} = 15\ \text{V}$	BF545A	2	-	6.5	mA
			BF545B	6	-	15	mA
			BF545C	12	-	25	mA
I_{GSS}	gate leakage current	$V_{GS} = -20\ \text{V}; V_{DS} = 0$	-	-0.5	-1000	pA	
		$V_{GS} = -20\ \text{V}; V_{DS} = 0;$ $T_j = 125\text{ °C}$	-	-	-100	nA	
$ y_{fs} $	forward transfer admittance	$V_{GS} = 0; V_{DS} = 15\ \text{V}$	3	-	6.5	mS	
$ y_{os} $	common source output admittance	$V_{GS} = 0; V_{DS} = 15\ \text{V}$	-	40	-	μS	

N-channel silicon junction field-effect transistors

BF545A; BF545B; BF545C

DYNAMIC CHARACTERISTICS

$T_{amb} = 25\text{ }^{\circ}\text{C}$; unless otherwise specified.

SYMBOL	PARAMETER	CONDITIONS	TYP.	UNIT
C_{is}	input capacitance	$V_{DS} = 15\text{ V}; V_{GS} = -10\text{ V}; f = 1\text{ MHz}$	1.7	pF
		$V_{DS} = 15\text{ V}; V_{GS} = 0; f = 1\text{ MHz}$	3	pF
C_{rs}	reverse transfer capacitance	$V_{DS} = 15\text{ V}; V_{GS} = -10\text{ V}; f = 1\text{ MHz}$	0.8	pF
		$V_{DS} = 15\text{ V}; V_{GS} = 0; f = 1\text{ MHz}$	0.9	pF
g_{is}	common source input conductance	$V_{DS} = 10\text{ V}; I_D = 1\text{ mA}; f = 100\text{ MHz}$	15	μS
		$V_{DS} = 10\text{ V}; I_D = 1\text{ mA}; f = 450\text{ MHz}$	300	μS
g_{fs}	common source transfer conductance	$V_{DS} = 10\text{ V}; I_D = 1\text{ mA}; f = 100\text{ MHz}$	2	mS
		$V_{DS} = 10\text{ V}; I_D = 1\text{ mA}; f = 450\text{ MHz}$	1.8	mS
g_{rs}	common source reverse conductance	$V_{DS} = 10\text{ V}; I_D = 1\text{ mA}; f = 100\text{ MHz}$	-6	μS
		$V_{DS} = 10\text{ V}; I_D = 1\text{ mA}; f = 450\text{ MHz}$	-40	μS
g_{os}	common source output conductance	$V_{DS} = 10\text{ V}; I_D = 1\text{ mA}; f = 100\text{ MHz}$	30	μS
		$V_{DS} = 10\text{ V}; I_D = 1\text{ mA}; f = 450\text{ MHz}$	60	μS

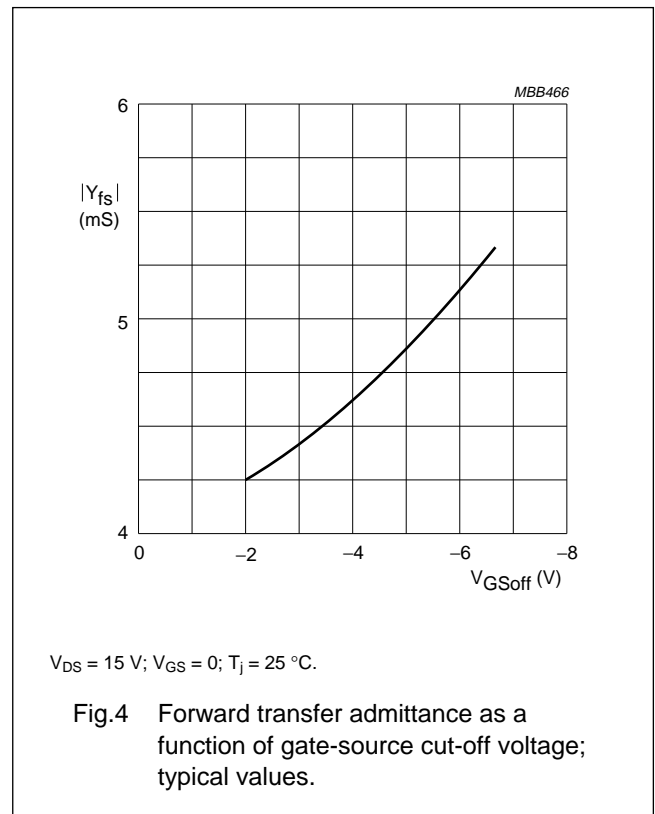
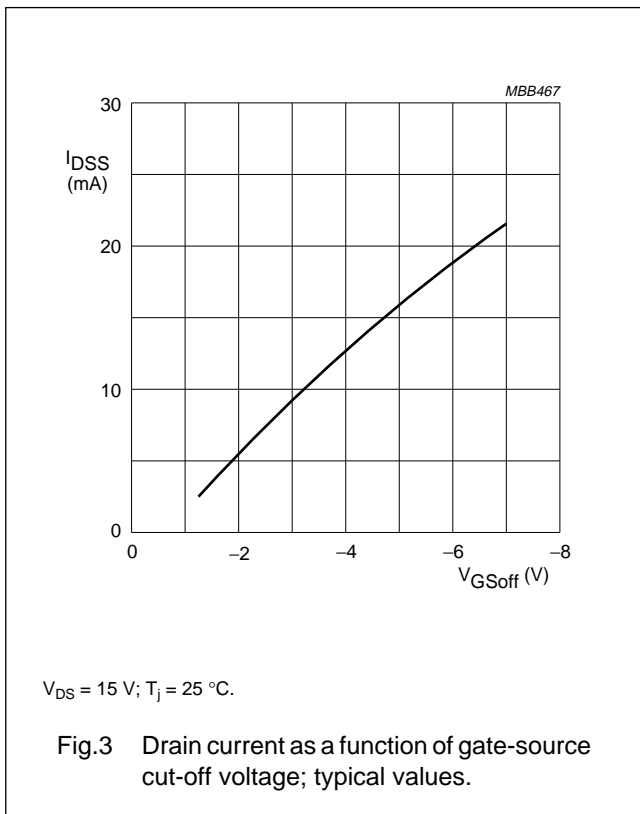

N-channel silicon junction field-effect transistors

BF545A; BF545B; BF545C

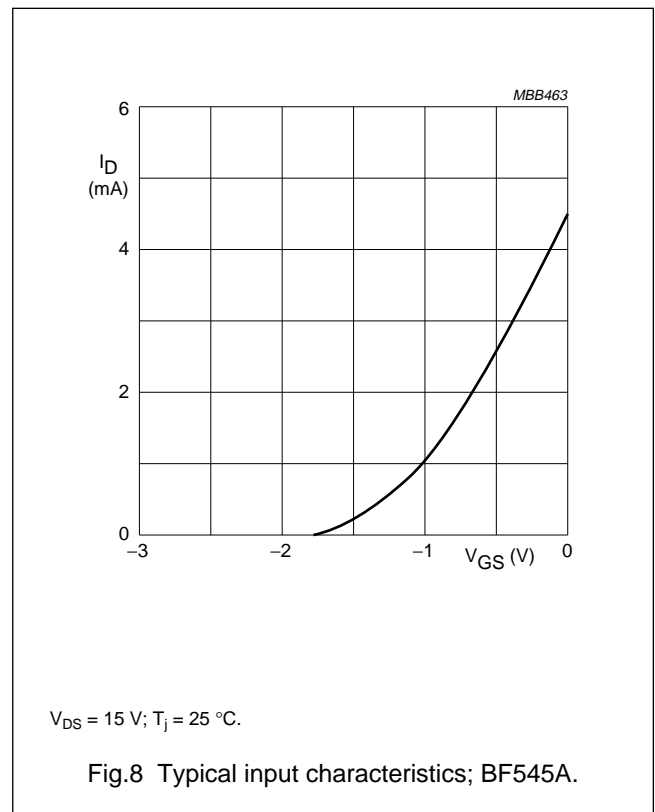
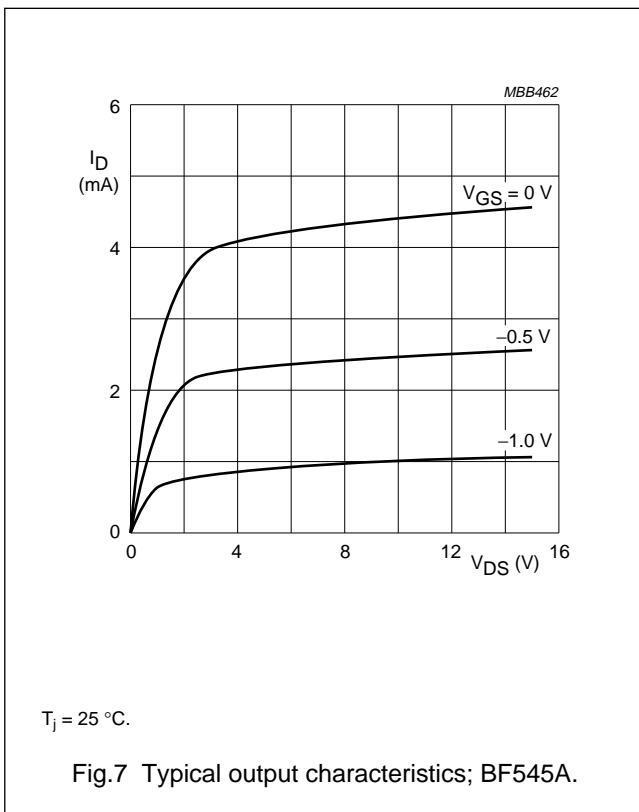
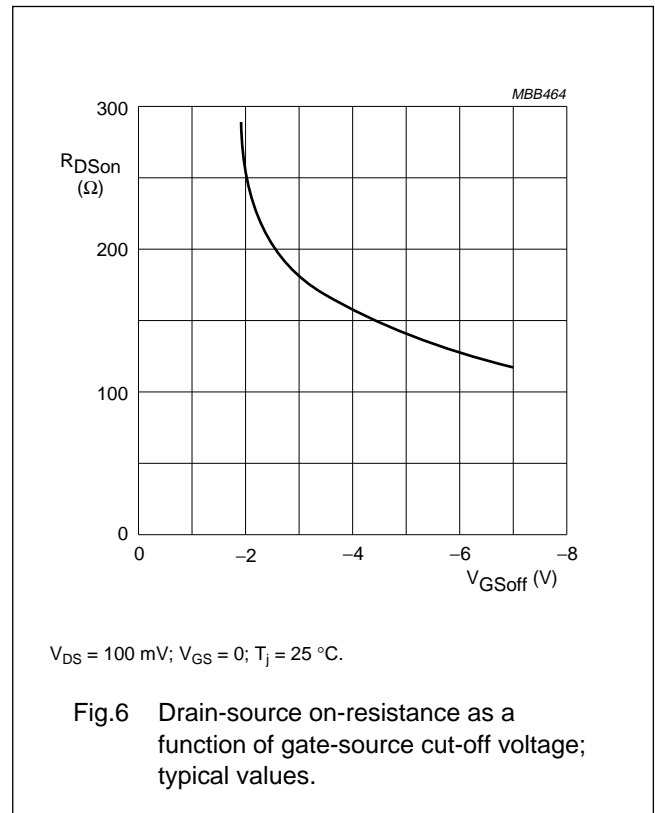
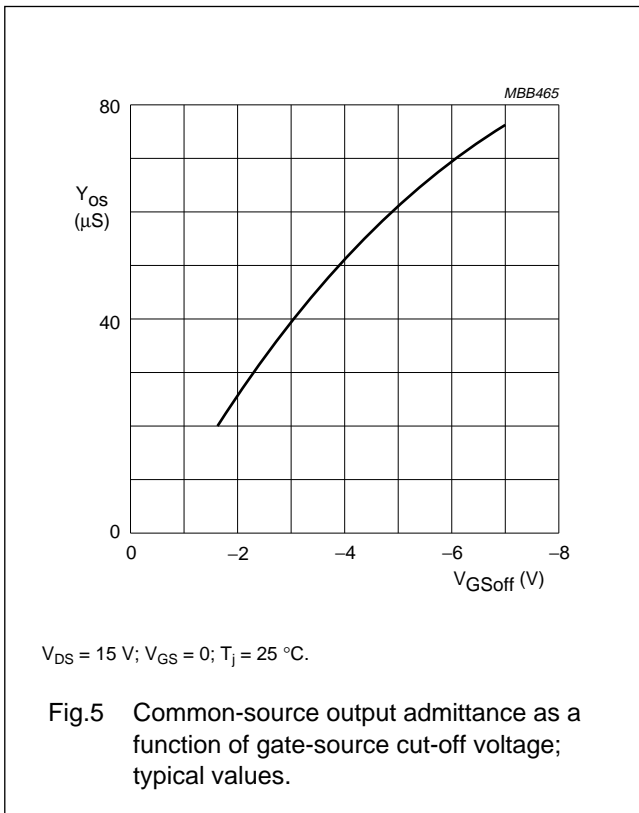

N-channel silicon junction field-effect transistors

BF545A; BF545B; BF545C

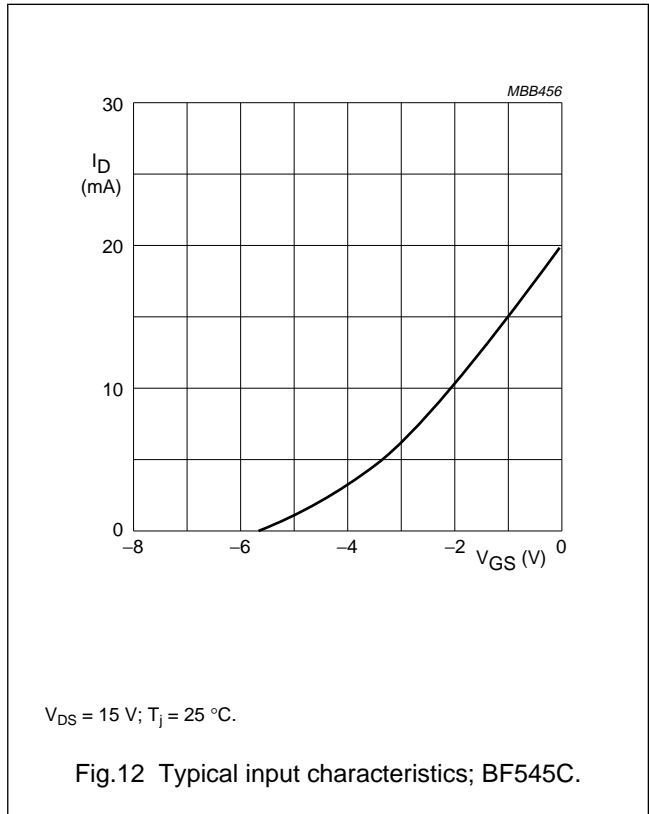
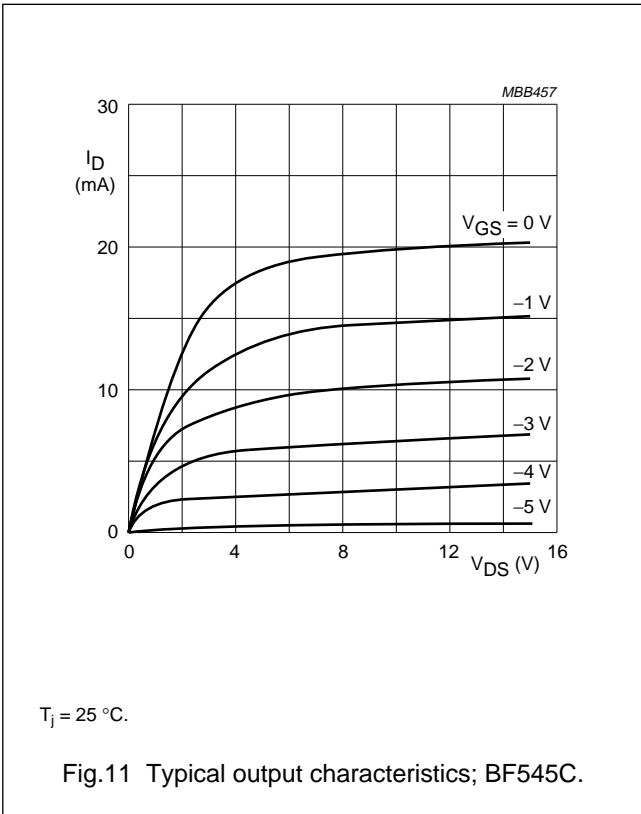
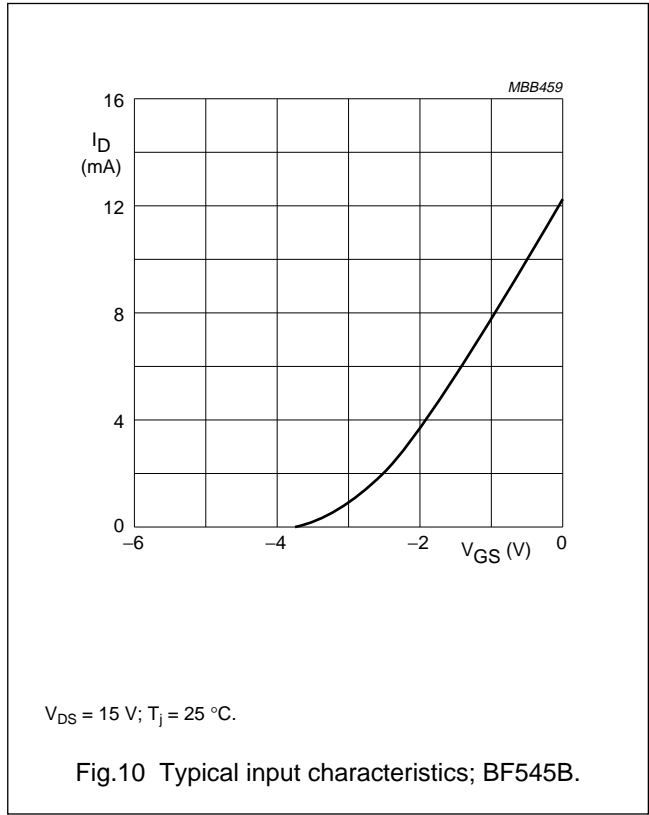
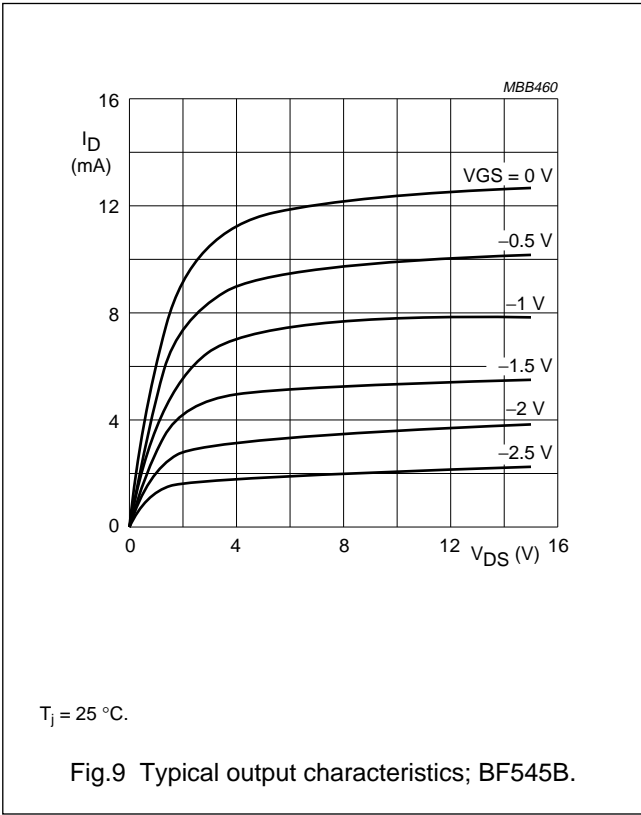

N-channel silicon junction field-effect transistors

BF545A; BF545B; BF545C

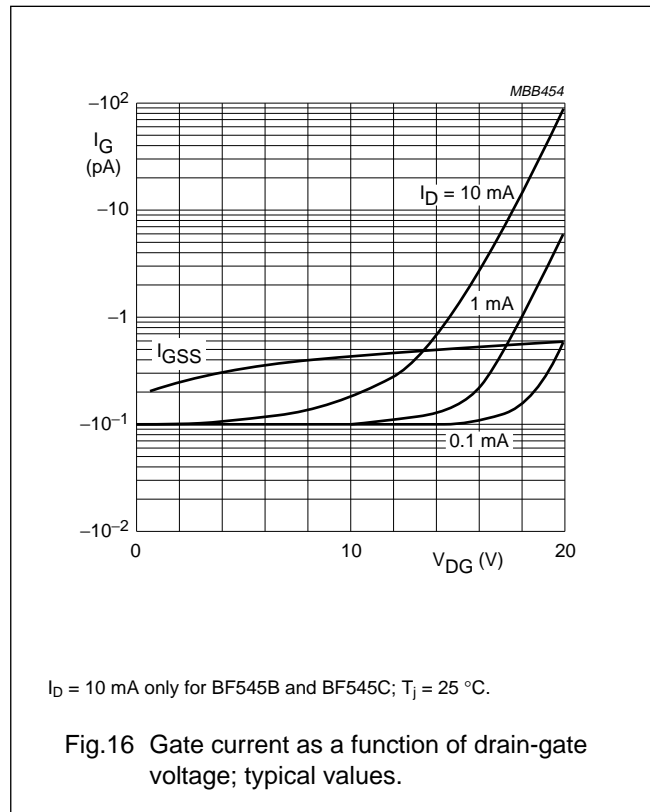
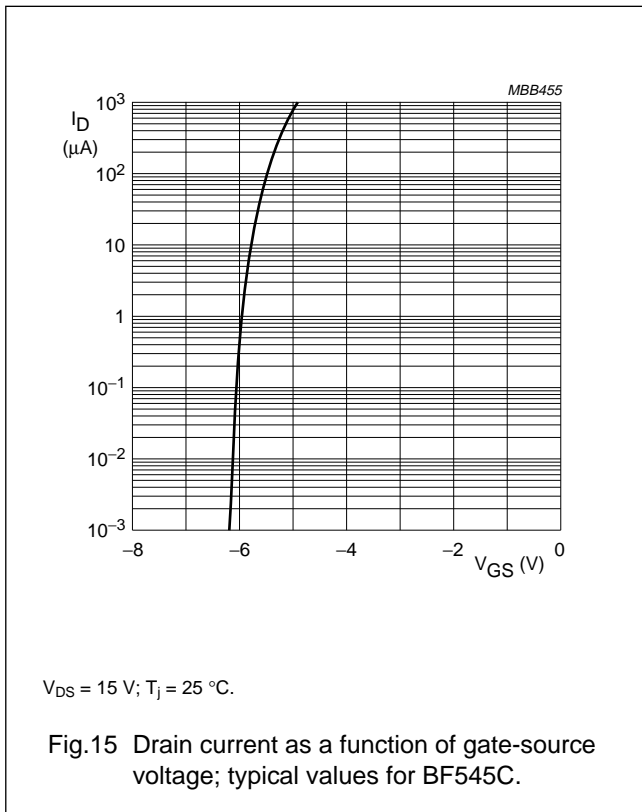
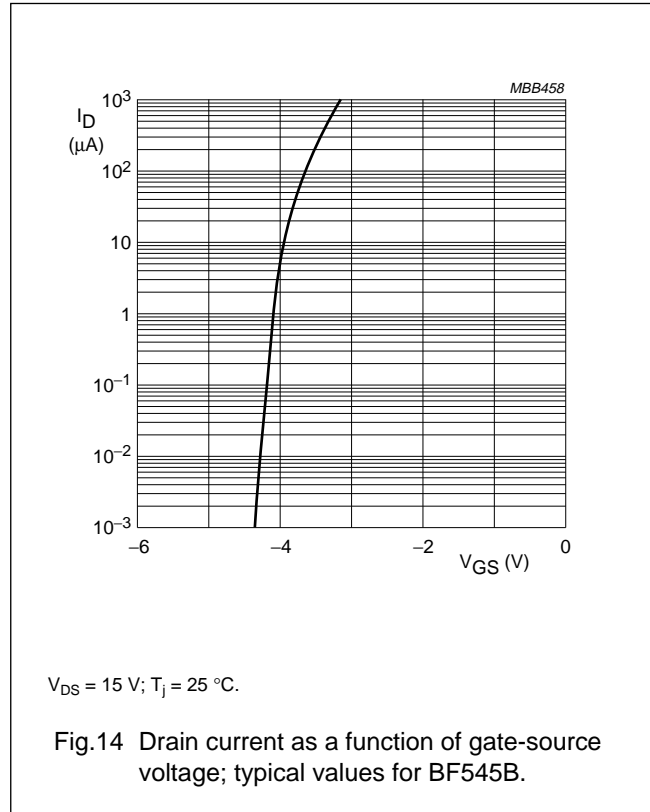
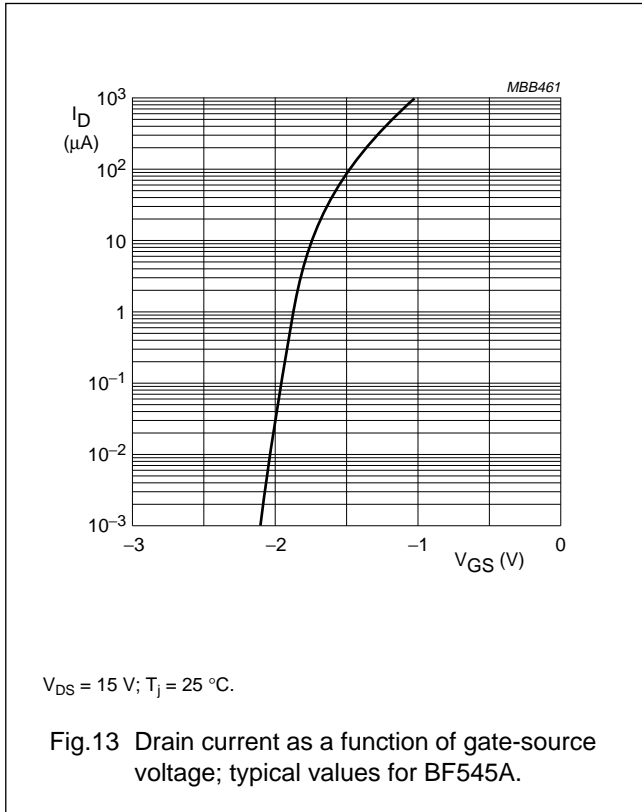

N-channel silicon junction
field-effect transistors

BF545A; BF545B; BF545C

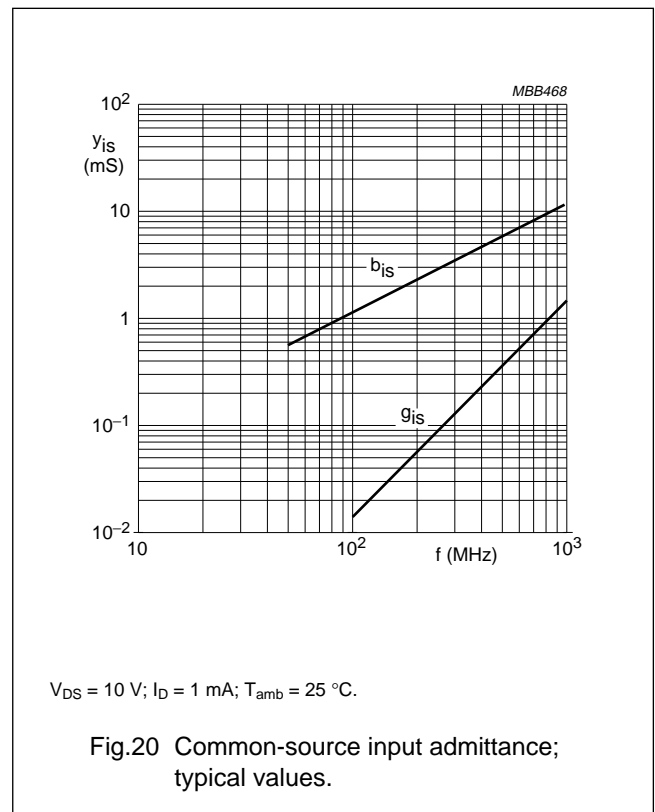
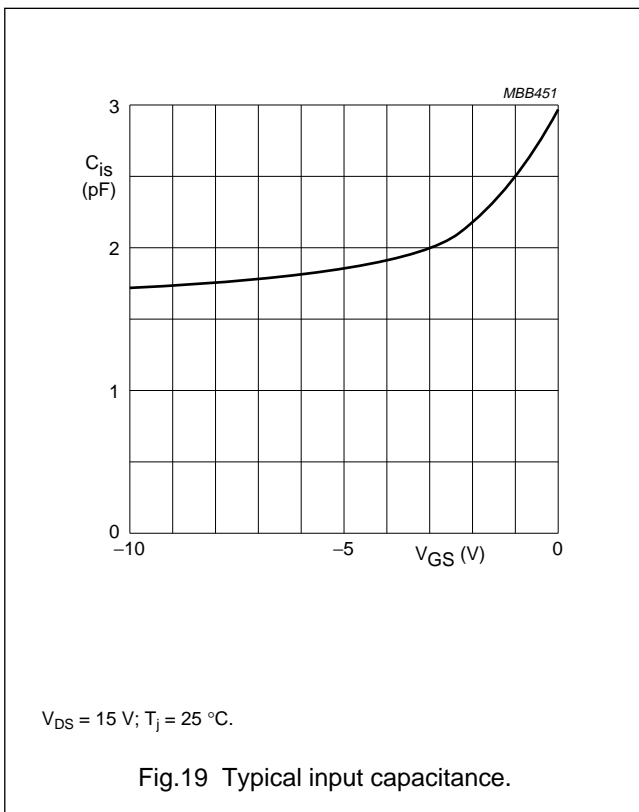
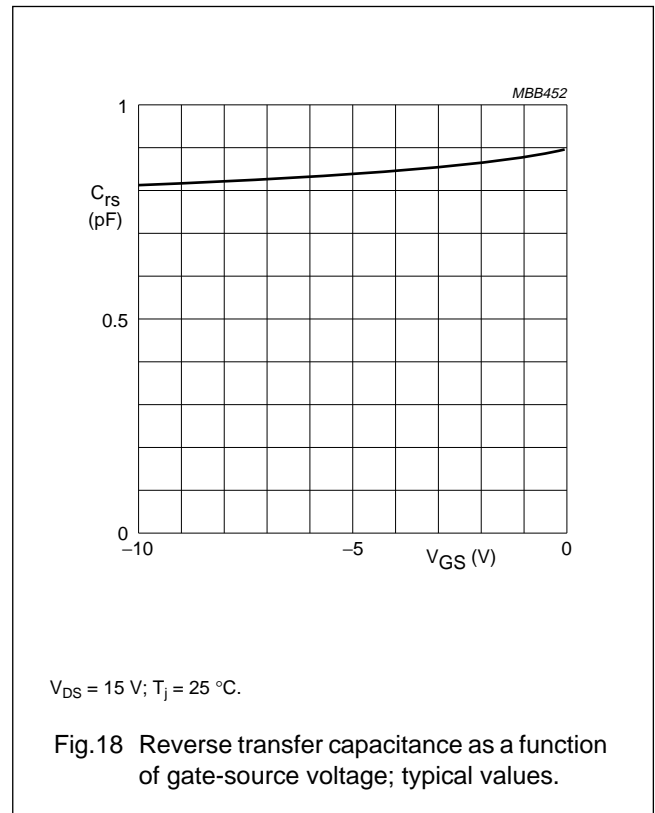
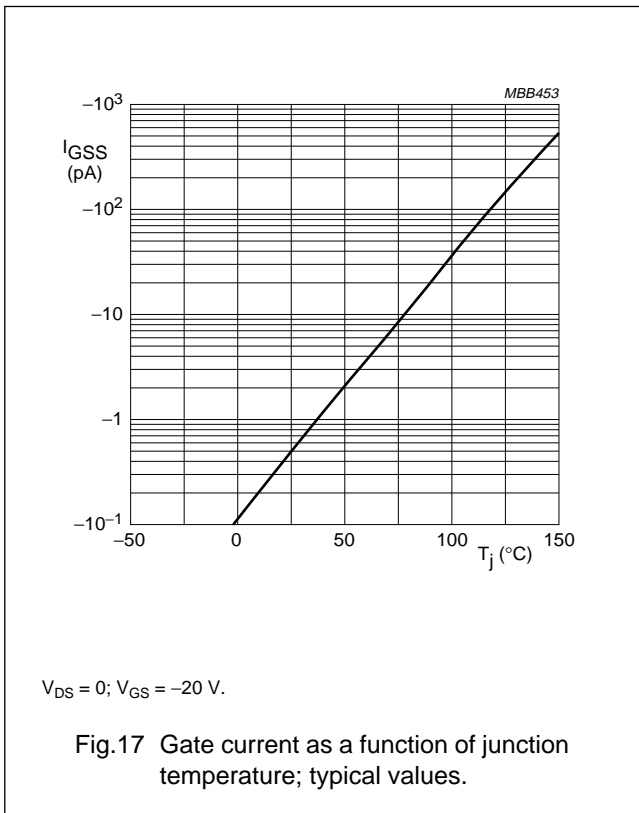

N-channel silicon junction
field-effect transistors

BF545A; BF545B; BF545C

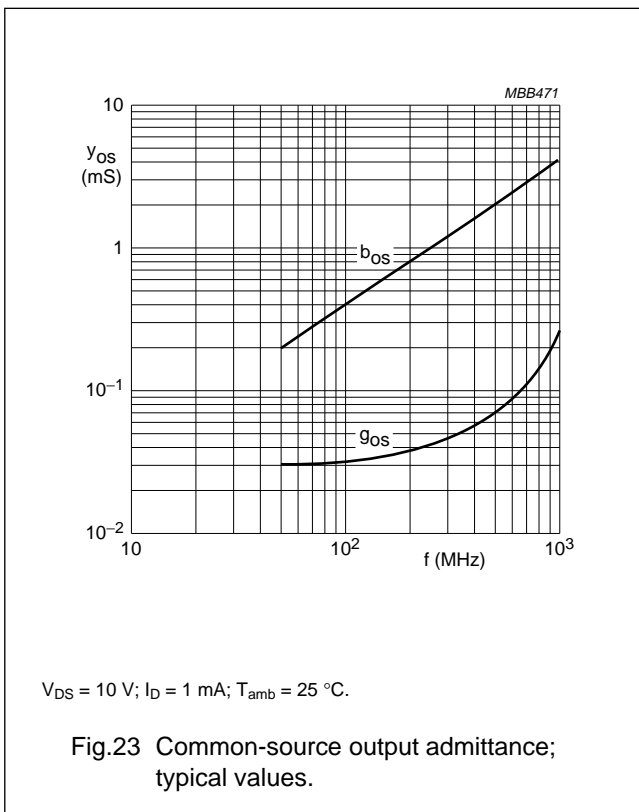
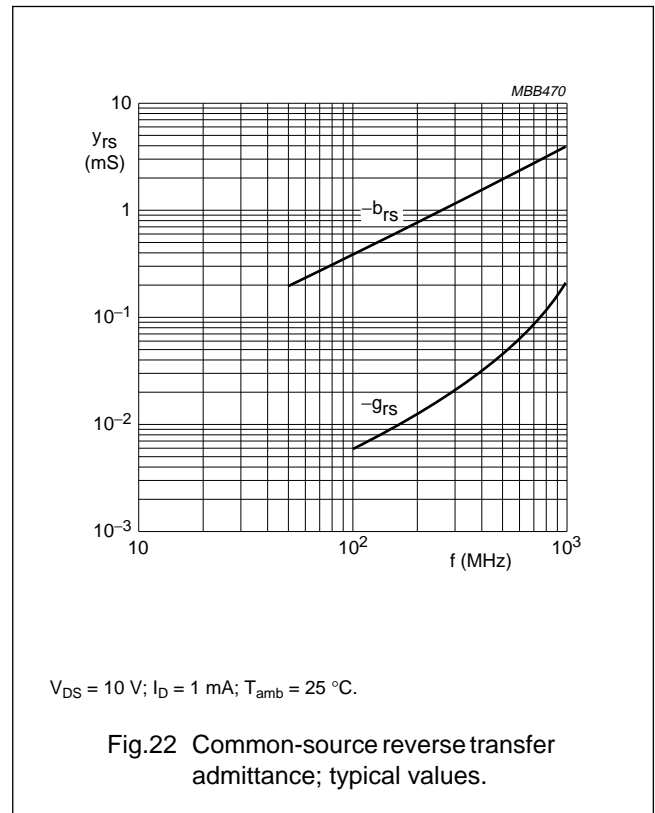
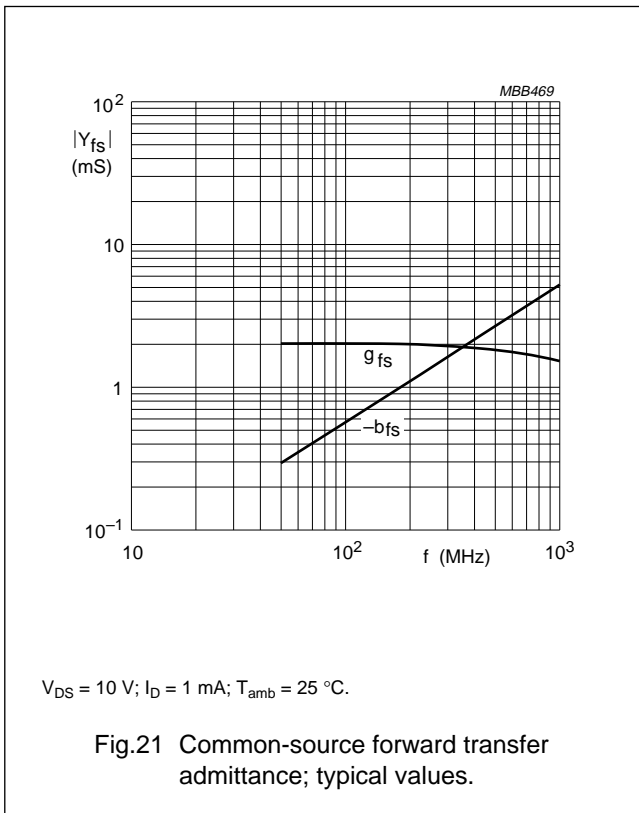

N-channel silicon junction field-effect transistors

BF545A; BF545B; BF545C

PACKAGE OUTLINE

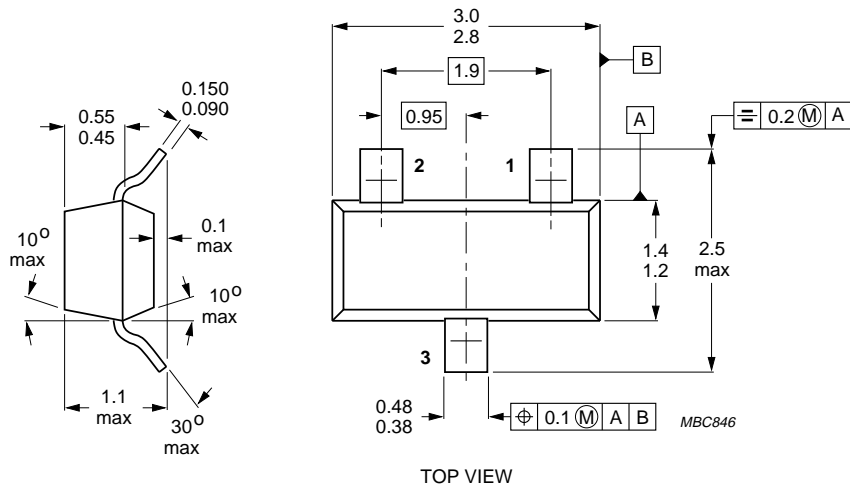

Dimensions in mm.

Fig.24 SOT23.

N-channel silicon junction field-effect transistors

BF545A; BF545B; BF545C

DEFINITIONS

Data Sheet Status	
Objective specification	This data sheet contains target or goal specifications for product development.
Preliminary specification	This data sheet contains preliminary data; supplementary data may be published later.
Product specification	This data sheet contains final product specifications.
Limiting values	
Limiting values given are in accordance with the Absolute Maximum Rating System (IEC 134). Stress above one or more of the limiting values may cause permanent damage to the device. These are stress ratings only and operation of the device at these or at any other conditions above those given in the Characteristics sections of the specification is not implied. Exposure to limiting values for extended periods may affect device reliability.	
Application information	
Where application information is given, it is advisory and does not form part of the specification.	

LIFE SUPPORT APPLICATIONS

These products are not designed for use in life support appliances, devices, or systems where malfunction of these products can reasonably be expected to result in personal injury. Philips customers using or selling these products for use in such applications do so at their own risk and agree to fully indemnify Philips for any damages resulting from such improper use or sale.